



DORO
LIGHTING SOLUTIONS

INDOOR **CATALOG 2**

QUALITY

At DORO Lights, quality is embedded in every step—from sourcing premium materials to meticulous craftsmanship. Our lights undergo strict checks to ensure they meet the highest standards before reaching our customers.



INNOVATION

We constantly push boundaries by integrating smart technology and ontemporary design trends. DORO Lights creates unique lighting solutions that enhance both ambiance and functionality.



WARRANTY

We believe in the durability of our products, which is why each DORO light comes with a comprehensive warranty. It reflects our confidence and commitment to long-term customer trust and satisfaction.

The History of Lights



1802

Humphry Davy

Invented the Electrical ARC lamp.



1840

Warren de la Rue

Built a light bulb using a platinum filament that was coiled inside a vacuum tube.

1874

Henry Woodwar & Mathew Evans

Built a light bulb using a platinum filament that was coiled inside a vacuum tube.

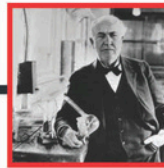
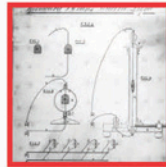

1878

Thomas Edison

Filed a patent under the label "improvement in Electric Lights."

1879

Edison

Submitted another patent.

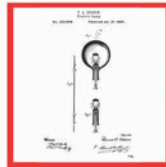

1880

Edison

Began marketing and manufacturing the latest version of his bulb to commercial clients & built the first central power plant in the U.S

1893

General Electric

Produced the first enclosed carbon arc lamp for commercial clients.

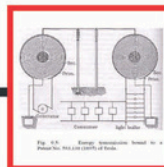

1893

Nikla Tesla

Demonstrated the possibility of wireless electricity, which he used to light a geissler tube.

1901

Peter Cooper Hewitt

Introduced the Mercury-Vapor Lamp (gas discharge lamp).

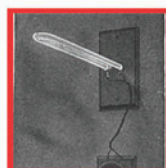

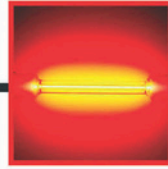

1910

Georges Claude
Demonstrated Neon Lighting.

1926

Edmund Germer
Submitted his patent for the first fluorescent lamp.



1938

Fluorescent lighting
technology was commercialize



1961

James Beard & Gary Pittman
Invented LEDs



1962

Nick Holonyak Jr.
produced the first LED that emitted light in a visible brand

1872

M. George Craford
Produced a yellow LED.



1979

Shuji Nakamura
Developed a blue LED.

1980

Philips
released its SL model of the compact fluorescent lamp (CFL).



2006

LEDs
were finally a competitive lighting option

2011

Philips
released its SL model of the compact fluorescent lamp (CFL).



NOW



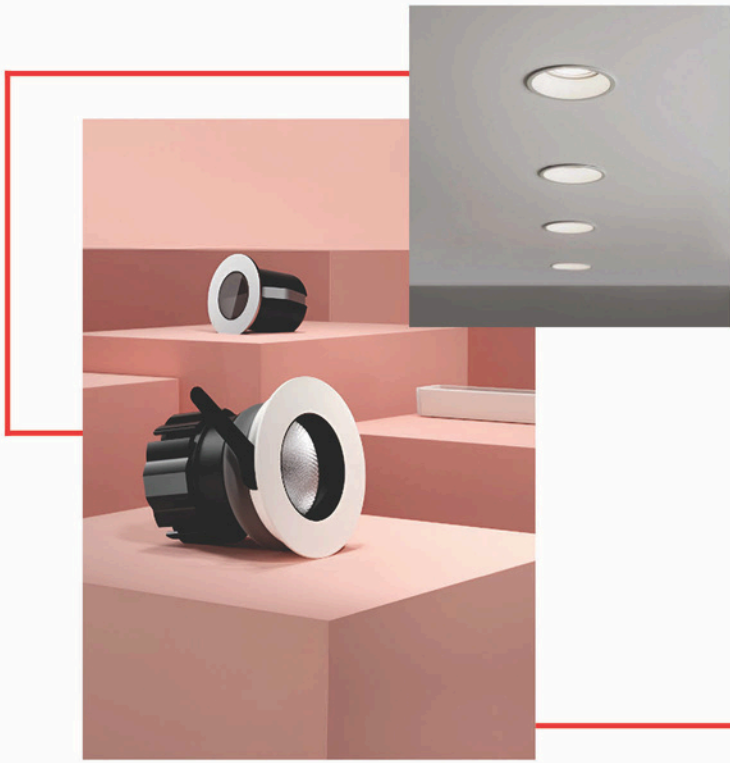



MODEL	WATT	OUTER SIZE	CUTOUT SIZE	BEAM ANGLE
DRL-R 2001	9 W	60x55 MM	55 MM	36°
DRL-R 2002	12 W	80x62 MM	75 MM	36°

DRIVERS



COLOUR TEMPERATURE



LED





MODEL	WATT	OUTER SIZE	CUTOUT SIZE	BEAM ANGLE		
				24°	36°	60°
DRL-R 2003	7 W	40X76MM	35 MM	24°	36°	60°
DRL-R 2004	12 W	55X76 MM	50 MM	38°	36°	60°
DRL-R 2005	18 W	70X85 MM	70 MM	38°	36°	60°

DRIVERS



COLOUR TEMPERATURE



LED





MODEL	WATT	OUTER SIZE	CUTOUT SIZE	BEAM ANGLE		
				24°	36°	60°
DRL-R 2006	7 W	40X83MM	35 MM	24°	36°	60°
DRL-R 2007	12 W	60X90 MM	50 MM	38°	36°	60°

DRIVERS

FULHAM
Harness the Horsepower

OSRAM

EAGLERISE

b,ag, India
Reliable | Intelligent | Drivers

COLOUR TEMPERATURE

27K 3K 4K 5K 6K 3in1 CCT TUNEABLE

LED

BRIDGELUX

CREE

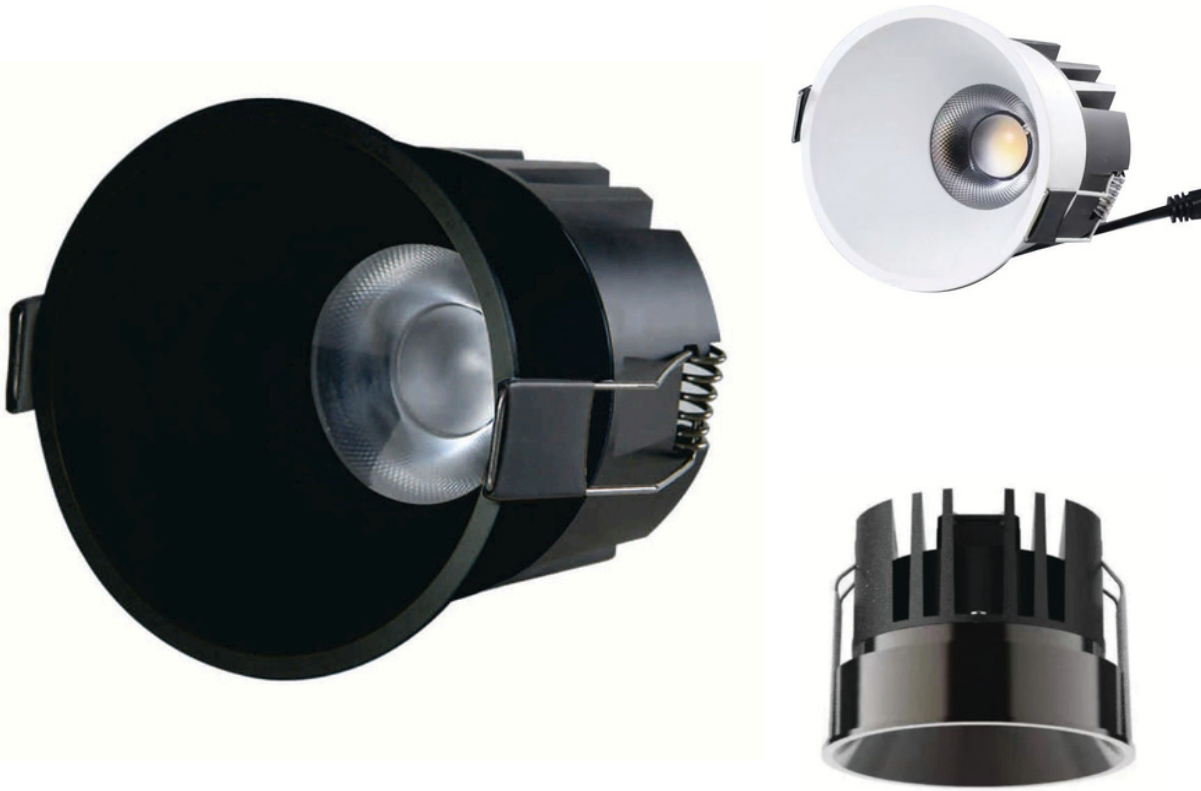

MODEL	WATT	OUTER SIZE	CUTOUT SIZE	BEAM ANGLE
DRL-R 2008	7 W	60X56	55 MM	24°
DRL-R 2009	12 W	70X60 MM	70 MM	38°
DRL-R 2010	18 W	70X100 MM	65 MM	38°

DRIVERS



COLOUR TEMPERATURE



LED





MODEL	WATT	OUTER SIZE	CUTOUT SIZE	BEAM ANGLE
DRL-R 2011	7 W	70x45 MM	55 MM	36°
DRL-R 2012	12 W	80x48 MM	75 MM	36°
DRL-R 2013	18 W	90x55 MM	85 MM	36°

DRIVERS



COLOUR TEMPERATURE



LED





MODEL	WATT	OUTER SIZE	CUTOUT SIZE	BEAM ANGLE
DRL-R 2014	7 W	43x82 MM	35 MM	36°
DRL-R 2015	12 W	53X106 MM	45 MM	36°
DRL-R 2016	18 W	63X112 MM	55 MM	36°

DRIVERS

FULHAM
Harness the Horsepower

OSRAM

EAGLERISE

b,ag, India
Reliable | Intelligent | Drivers

COLOUR TEMPERATURE

27K 3K 4K 5K 6K 3in1 CCT TUNEABLE

LED

BRIDGELUX

CREE



MODEL	WATT	OUTER SIZE	CUTOUT SIZE	BEAM ANGLE
DRL-R 2017	9 W	60x55 MM	55 MM	36°
DRL-R 2018	12 W	80x62 MM	75 MM	36°
DRL-R 2019	30 W	105x83 MM	95 MM	36°
DRL-R 2020	50 W	135x90 MM	125 MM	36°

DRIVERS

FULHAM
Harness the Horsepower

OSRAM

EAGLERISE

b,ag, India
Reliable | Intelligent | Drivers

COLOUR TEMPERATURE

27K 3K 4K 5K 6K 3in1 CCT TUNEABLE

LED

BRIDGELUX

CREE



MODEL	WATT	OUTER SIZE	CUTOUT SIZE	BEAM ANGLE
DRL-R 2021	12 - 15 W	50x105 MM	45 MM	36°
DRL-R 2022	18 - 22 W	60x105 MM	55 MM	36°

DRIVERS



COLOUR TEMPERATURE



LED





MODEL	WATT	OUTER SIZE	CUTOUT SIZE	BEAM ANGLE
DRL-R 2023	7 W	53X61 MM	45 MM	36°
DRL-R 2024	12 W	63X71 MM	55 MM	36°
DRL-R 2025	18 W	83X83 MM	75 MM	36°

DRIVERS

FULHAM
Harness the Horsepower

OSRAM

EAGLERISE

bag, India
Reliable | Intelligent | Drivers

COLOUR TEMPERATURE

27K 3K 4K 5K 6K 3in1 CCT TUNEABLE

LED

BRIDGELUX

CREE



MODEL	WATT	OUTER SIZE	CUTOUT SIZE	BEAM ANGLE
DRL-R 2026	7 W	68X66 MM	60 MM	24°
DRL-R 2027	12 W	83X75 MM	75 MM	38°
DRL-R 2028	18 W	93X85 MM	85 MM	38°

DRIVERS



COLOUR TEMPERATURE



LED





MODEL	WATT	OUTER SIZE	CUTOUT SIZE	BEAM ANGLE		
				24°	36°	60°
DRL-R 2029	7 W	60X56	55 MM	24°	36°	60°
DRL-R 2030	12 W	80X56 MM	75 MM	38°	36°	60°

DRIVERS



COLOUR TEMPERATURE



LED



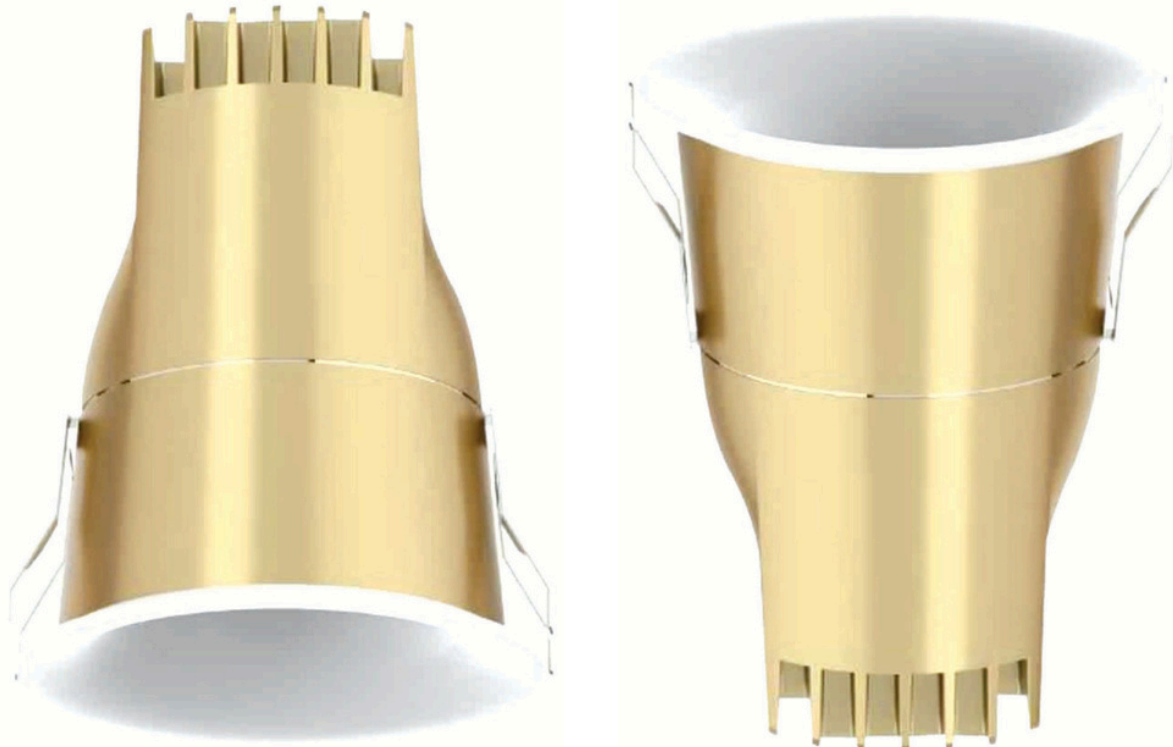

MODEL	WATT	OUTER SIZE	CUTOUT SIZE	BEAM ANGLE
DRL-R 2031	7 W	43X65	35 MM	24°
DRL-R 2032	12 W	63X94 MM	55 MM	38°
DRL-R 2033	18 W	83X103 MM	75 MM	38°

DRIVERS

FULHAM
Harness the Horsepower

OSRAM

EAGLERISE

b,ag, India
Reliable | Intelligent | Drivers

COLOUR TEMPERATURE

27K 3K 4K 5K 6K 3in1 CCT TUNEABLE

LED

BRIDGELUX

CREE



MODEL	WATT	OUTER SIZE	CUTOUT SIZE	BEAM ANGLE
DRL-R 2034	7 W	62X25	55 MM	38°
DRL-R 2035	12 W	28X72 MM	65 MM	38°
DRL-R 2036	18 W	31X83 MM	75 MM	38°

DRIVERS



COLOUR TEMPERATURE

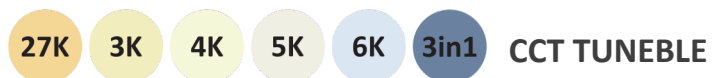

LED





MODEL	WATT	OUTER SIZE	CUTOUT SIZE	BEAM ANGLE
DRL-R 2037	7 W	60X52 MM	55 MM	36°
DRL-R 2038	12 W	80X50 MM	75 MM	36°
DRL-R 2039	18 W	100X62 MM	95 MM	36°

DRIVERS

FULHAM
Harness the Horsepower

OSRAM

EAGLERISE

bag, India
Reliable | Intelligent | Drivers

COLOUR TEMPERATURE

27K 3K 4K 5K 6K 3in1 CCT TUNEABLE

LED

BRIDGELUX

CREE



MODEL	WATT	OUETR SIZE	CUTOUT SIZE	BEAM ANGLE
DRL-R 2040	7 W	54X62 MM	44 MM	36°
DRL-R 2041	12 W	70X70 MM	60 MM	36°
DRL-R 2042	18 W	80X75 MM	70 MM	36°

DRIVERS

FULHAM
Harness the Horsepower

OSRAM

EAGLERISE

b,ag, India
Reliable | Intelligent | Drivers

COLOUR TEMPERATURE

27K 3K 4K 5K 6K 3in1 CCT TUNEABLE

LED

BRIDGELUX

CREE



MODEL	WATT	OUTER SIZE	CUTOUT SIZE	BEAM ANGLE		
				24°	38°	60°
DRL-R 2043	7 W	60X75 MM	55 MM	24°	38°	60°
DRL-R 2044	12 W	70X75 MM	65 MM	24°	38°	60°
DRL-R 2045	18 W	83X85 MM	78 MM	24°	38°	60°

DRIVERS



COLOUR TEMPERATURE



LED



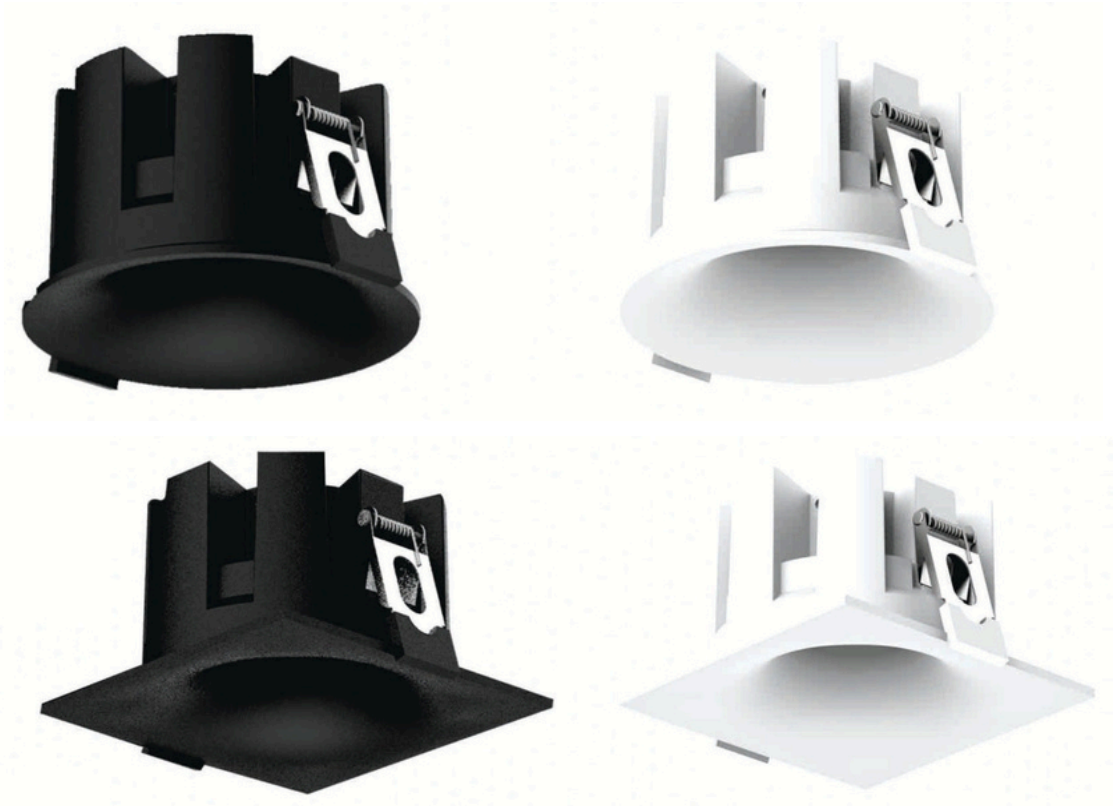

MODEL	WATT	ROUND SIZE	CUTOUT SIZE	BEAM ANGLE
DRL-R 2046	7 W	65X46	55 MM	24°
DRL-R 2047	12 W	80X52 MM	75 MM	38°

MODEL	WATT	SQURE SIZE	CUTOUT SIZE	BEAM ANGLE
DRL-R 2048	7 W	65X65	55 MM	24°
DRL-R 2049	12 W	85X85 MM	75 MM	38°

DRIVERS

FULHAM
Harness the Horsepower

OSRAM

EAGLERISE

b,ag, India
Reliable | Intelligent | Drivers

COLOUR TEMPERATURE

27K 3K 4K 5K 6K 3in1 CCT TUNEABLE

LED

BRIDGELUX

CREE



MODEL	WATT	OUTER SIZE	CUTOUT SIZE	BEAM ANGLE
DRL-R 2050	7 W	65X85	55 MM	24°
DRL-R 2051	12 W	75X83 MM	65 MM	38°
DRL-R 2052	18 W	85X86 MM	75 MM	38°

DRIVERS

FULHAM
Harness the Horsepower

OSRAM

EAGLERISE

b,ag, India
Reliable | Intelligent | Drivers

COLOUR TEMPERATURE

27K 3K 4K 5K 6K 3in1 CCT TUNEABLE

LED

BRIDGELUX

CREE



MODEL	WATT	OUT	CUTOUT	HEIGHT	BEAM ANGEL	BODY COLOUR
DRL-R 2053	7 W	56	50	92	38°	BK/WH
DRL-R 2054	12 W	75	70	106	38°	BK/WH
DRL-R 2055	18 W	91	85	120	38°	BK/WH

DRIVERS

FULHAM
Harness the Horsepower

OSRAM

EAGLERISE

bag, India
Reliable | Intelligent | Drivers

COLOUR TEMPERATURE

27K 3K 4K 5K 6K 3in1 CCT TUNEABLE

LED

BRIDGELUX

CREE

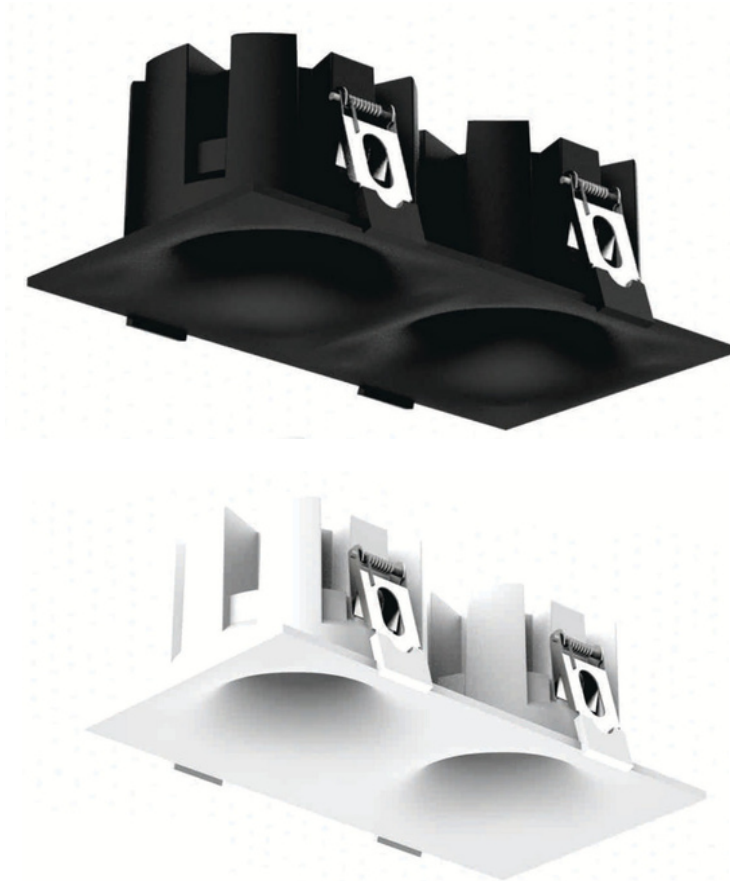

MODEL	WATT	OUTER SIZE	CUTOUT SIZE	BEAM ANGLE
DRL-R 2056	7X2 W	122X65	113X55 MM	38°
DRL-R 2057	12X2 W	162X85 MM	153X75 MM	38°

DRIVERS



COLOUR TEMPERATURE



LED





MODEL	WATT	OUTER SIZE	CUTOUT SIZE	BEAM ANGLE
DRL-R 2058	7 W	50X70	65 MM	36°
DRL-R 2059	12 W	85X65 MM	75 MM	36°
DRL-R 2060	18 W	75X95 MM	90 MM	36°

DRIVERS

FULHAM
Harness the Horsepower

OSRAM

EAGLERISE

bag, India
Reliable | Intelligent | Drivers

COLOUR TEMPERATURE

27K 3K 4K 5K 6K 3in1 CCT TUNEABLE

LED

BRIDGELUX

CREE



MODEL	WATT	OUTER SIZE	CUTOUT SIZE	BEAM ANGLE		
				24°	38°	60°
DRL-R 2061	7 W	40X58 MM	35 MM	24°	38°	60°
DRL-R 2062	12 W	60X88 MM	52 MM	24°	38°	60°
DRL-R 2063	18 W	75X95 MM	62 MM	24°	38°	60°

DRIVERS



COLOUR TEMPERATURE



LED





MODEL	WATT	OUTER SIZE	CUTOUT SIZE	BEAM ANGLE		
DRL-R 2064	3 W	47X73 MM	30 MM	60°		
DRL-R 2065	7 W	70X57 MM	55 MM	24°	38°	60°
DRL-R 2066	12 W	85X65 MM	75 MM	24°	38°	60°
DRL-R 2067	24 W	95X90 MM	86 MM	24°	38°	60°

DRIVERS



COLOUR TEMPERATURE



LED





MODEL	WATT	OUTER SIZE	CUTOUT SIZE	BEAM ANGLE		
				24°	36°	60°
DRL-R 2068	7 W	75X60 MM	65 MM	24°	36°	60°
DRL-R 2069	12 W	85X80 MM	75 MM	38°	36°	60°
DRL-R 2070	18 W	95X100 MM	85 MM	38°	36°	60°

DRIVERS



COLOUR TEMPERATURE



LED





MODEL	WATT	OUT	CUTOUT	HEIGHT	BEAM ANGEL	BODY COLOUR
DRL-R 2071	7 W	68	60	62	25°	BK/WH
DRL-R 2072	12 W	85	75	76	38°	BK/WH
DRL-R 2073	24 W	162X83	755X75	90	38°	BK/WH

DRIVERS



COLOUR TEMPERATURE



LED





MODEL	WATT	OUTER SIZE	CUTOUT SIZE	BEAM ANGLE		
DRL-R 2074	3 W	38X28 MM	25 MM	60°		
DRL-R 2075	7 W	63X60 MM	57 MM	24°	38°	60°
DRL-R 2076	12 W	84X79 MM	74 MM	24°	38°	60°
DRL-R 2077	18 W	95X100 MM	85 MM	24°	38°	60°
DRL-R 2078	24 W	115X105 MM	105 MM	24°	38°	60°

DRIVERS



COLOUR TEMPERATURE



LED





MODEL	WATT	OUTER SIZE	CUTOUT SIZE	BEAM ANGLE
DRL-R 2079	7 W	62x43 MM	55 MM	36°
DRL-R 2080	12 W	82X42 MM	75 MM	36°
DRL-R 2081	18 W	105X49 MM	96 MM	36°

DRIVERS

FULHAM
Harness the Horsepower

OSRAM

EAGLERISE

bag, India
Reliable | Intelligent | Drivers

COLOUR TEMPERATURE

27K 3K 4K 5K 6K 3in1 CCT TUNEABLE

LED

BRIDGELUX

CREE



MODEL	WATT	OUTER SIZE	CUTOUT SIZE	BEAM ANGLE		
				24°	38°	60°
DRL-R 2082	6 W	67X45 MM	60 MM	24°	38°	60°
DRL-R 2083	12 W	85X55 MM	75 MM	24°	38°	60°
DRL-R 2084	7X2 W	132X73X46 MM	122x63 MM	24°	38°	60°
DRL-R 2085	12X2 W	186X85X60 MM	158x75 MM	24°	38°	60°

DRIVERS

FULHAM
Harness the Horsepower

OSRAM

EAGLERISE

bag, India
Reliable | Intelligent | Drivers

COLOUR TEMPERATURE

27K 3K 4K 5K 6K 3in1 CCT TUNEABLE

LED

BRIDGELUX

CREE



MODEL	WATT	OUTER SIZE	CUTOUT SIZE	BEAM ANGLE		
				24°	36°	60°
DRL-R 2086	7 W	65X78 MM	55 MM	24°	36°	60°
DRL-R 2087	12 W	85X96 MM	75 MM	24°	36°	60°
DRL-R 2088	18 W	105X110MM	95 MM	24°	36°	60°
DRL-R 2089	24 W	105X121 MM	95 MM	24°	36°	60°

DRIVERS

FULHAM
Harness the Horsepower

OSRAM

EAGLERISE

b,ag, India
Reliable | Intelligent | Drivers

COLOUR TEMPERATURE

27K 3K 4K 5K 6K 3in1 CCT TUNEABLE

LED

BRIDGELUX

CREE



MODEL	WATT	OUTER SIZE	CUTOUT SIZE	BEAM ANGLE
DRL-R 2090	7 W	75x50 MM	65 MM	25°
DRL-R 2091	12 W	84x57 MM	78 MM	38°
DRL-R 2092	15 W	84x72 MM	78 MM	38°
DRL-R 2093	18 W	90x69 MM	84 MM	38°
DRL-R 2094	30 W	145x90 MM	135 MM	45°
DRL-R 2095	40 W	160x100MM	145 MM	45°
DRL-R 2096	50 W	160x100MM	145 MM	45°

DRIVERS

FULHAM
Harness the Horsepower

OSRAM

EAGLERISE

bag, India
Reliable | Intelligent | Drivers

COLOUR TEMPERATURE

27K 3K 4K 5K 6K 3in1 CCT TUNEABLE

LED

BRIDGELUX

CREE



MODEL	WATT	OUTER SIZE	CUTOUT SIZE	BEAM ANGLE		
				24°	36°	60°
DRL-R 2097	7 W	65X78 MM	55 MM	24°	36°	60°
DRL-R 2098	12 W	85X96 MM	75 MM	24°	36°	60°
DRL-R 2099	18 W	105X121 MM	95 MM	24°	36°	60°
DRL-R 2100	24 W	105X121 MM	95 MM	24°	36°	60°

DRIVERS

FULHAM
Harness the Horsepower

OSRAM

EAGLERISE

b,ag, India
Reliable | Intelligent | Drivers

COLOUR TEMPERATURE

27K 3K 4K 5K 6K 3in1 CCT TUNEABLE

LED

BRIDGELUX

CREE



MODEL	WATT	OUTER SIZE	CUTOUT SIZE	BEAM ANGLE		
				24°	38°	60°
DRL-R 2101	15 W	65X114 MM	55 MM	24°	38°	60°
DRL-R 2102	25 W	85X147 MM	75 MM	24°	38°	60°

DRIVERS



COLOUR TEMPERATURE



LED





MODEL	WATT	OUT	CUTOUT	HEIGHT	BEAM ANGLE	BODY COLOUR
DRL-R 2103	7 W	65	55	50	36°	BK/WH
DRL-R 2104	12 W	85	75	60	36°	BK/WH
DRL-R 2105	18 W	105	95	75	36°	BK/WH
DRL-R 2106	12X2 W	166X85	155X75	62	36°	BK/WH

DRIVERS

FULHAM
Harness the Horsepower

OSRAM

EAGLERISE

bag, India
Reliable | Intelligent | Drivers

COLOUR TEMPERATURE

27K 3K 4K 5K 6K 3in1 CCT TUNEABLE

LED

BRIDGELUX

CREE



MODEL	WATT	OUTER SIZE	CUTOUT SIZE	BEAM ANGLE
DRL-R 2107	3 W	30x40 MM	25 MM	36°
DRL-R 2108	7 W	42x60 MM	35 MM	36°
DRL-R 2109	12 W	55X62 MM	45 MM	36°
DRL-R 2110	18 W	55X112 MM	45 MM	36°

DRIVERS

FULHAM
Harness the Horsepower

OSRAM

EAGLERISE

bag, India
Reliable | Intelligent | Drivers

COLOUR TEMPERATURE

27K 3K 4K 5K 6K 3in1 CCT TUNEABLE

LED

BRIDGELUX

CREE



MODEL	WATT	OUTER SIZE	CUTOUT SIZE	BEAM ANGLE
DRL-R 2111	12 W	80x65 MM	75 MM	36°

DRIVERS



COLOUR TEMPERATURE





LED





	MODEL	WATT	DIMS	HEIGHT	BEAM ANGLE
	DRL-R 2112	7 W	50 MM	50 MM	36°
	DRL-R 2113	12 W	50 MM	65 MM	36°
	DRL-R 2114	15 W	50 MM	85 MM	36°

	MODEL	WATT	DIMS	HEIGHT	BEAM ANGLE
	DRL-R 2115	12 W	50 MM	70 MM	36°
	DRL-R 2116	15 W	50 MM	70 MM	36°

	MODEL	WATT	DIMS	HEIGHT	BEAM ANGLE
	DRL-R 2117	10 W	50 MM	55 MM	36°
	DRL-R 2118	12 W	50 MM	75 MM	36°

DRIVERS

FULHAM
Harness the Horsepower

OSRAM

EAGLERISE

bag, India
Reliable | Intelligent | Drivers

COLOUR TEMPERATURE

27K 3K 4K 5K 6K 3in1 CCT TUNEABLE

LED

BRIDGELUX

CREE



MODEL	WATT	OUTER SIZE	BEAM ANGLE
DRL-R 2119	7 W	64X74MM	36°
DRL-R 2120	12 W	70X90 MM	36°
DRL-R 2121	18 W	70X90 MM	36°

DRIVERS



COLOUR TEMPERATURE



LED





MODEL	WATT	OUTER SIZE	CUTOUT SIZE	BEAM ANGLE		
				24°	36°	60°
DRL-R 2122	12 W	85X70	75 MM	24°	36°	60°
DRL-R 2123	18 W	78X110 MM	95 MM	24°	36°	60°
DRL-R 2124	24 W	91X135 MM	125 MM	24°	36°	60°

DRIVERS

FULHAM
Harness the Horsepower

OSRAM

EAGLERISE

bag, India
Reliable | Intelligent | Drivers

COLOUR TEMPERATURE

27K 3K 4K 5K 6K 3in1 CCT TUNEABLE

LED

BRIDGELUX

CREE



MODEL	WATT	OUTER SIZE	BEAM ANGLE
DRL-R 2125	12 W	55X162 MM	38°

DRIVERS



COLOUR TEMPERATURE



LED





MODEL	WATT	ROUND SIZE	SQUARE SIZE	BEAM ANGLE
DRL-R 2126	7W	55X73 MM	55X55X73 MM	38°
DRL-R 2127	12W	74X100 MM	75X75X95 MM	38°
DRL-R 2128	24W 12x2	95X115 MM	95X95X120 MM	38°

DRIVERS



COLOUR TEMPERATURE



LED





MODEL	WATT	DIME	BEAM ANGLE	BODY COLOUR
DRL-R 2129	12 W	Ø85*71(H)MM	38°	WH/BK
DRL-R 2130	18 W	Ø100*120(H)MM	38°	WH/BK

DRIVERS

FULHAM
Harness the Horsepower

OSRAM

EAGLERISE

bag, India
Reliable | Intelligent | Drivers

COLOUR TEMPERATURE

27K 3K 4K 5K 6K 3in1 CCT TUNEABLE

LED

BRIDGELUX

CREE



MODEL	WATT	COLOUR	DIME	CUT-OUT	BEAM ANGLE	BODY COLOUR
DRL-R 2131	12W	WH/BK	Ø85*71(H)MM	78MM	38°	WHITE

DRIVERS

FULHAM
Harness the Horsepower

OSRAM

EAGLERISE

bag, India
Reliable | Intelligent | Drivers

COLOUR TEMPERATURE

27K 3K 4K 5K 6K 3in1 CCT TUNEABLE

LED

BRIDGELUX

CREE



MODEL	WATT	OUTER SIZE	BEAM ANGLE
DRL-R 2132	7 W	L-47XW-37-H117	36°
DRL-R 2133	12 W	L-67XW-37-H117	36°
DRL-R 2134	18 W	L-47XW-63-H117	36°
DRL-R 2135	30 W	L-187XW-37-H117	36°

DRIVERS



COLOUR TEMPERATURE



LED





MODEL	WATT	DIMENSION	BEAM ANGLE				BODY COLOUR
			15°	24°	38°	60°	
DRL-R 2136	10 W	50X135 MM	15°	24°	38°	60°	WH/BK
DRL-R 2137	15 W	60X150 MM	15°	24°	38°	60°	WH/BK
DRL-R 2138	20 W	80X150 MM	15°	24°	38°	60°	WH/BK
DRL-R 2139	24 W	80X180 MM	15°	24°	38°	60°	WH/BK
DRL-R 2140	30 W	90X180 MM	15°	24°	38°	60°	WH/BK
DRL-R 2141	36 W	100X180 MM	15°	24°	38°	60°	WH/BK
DRL-R 2142	40 W	120X175 MM	15°	24°	38°	60°	WH/BK

DRIVERS

FULHAM
Harness the Horsepower

OSRAM

EAGLERISE

b,ag, India
Reliable | Intelligent | Drivers

COLOUR TEMPERATURE

27K 3K 4K 5K 6K 3in1 CCT TUNEABLE

LED

BRIDGELUX

CREE



MODEL	WATT	DIMENSION	BEAM ANGLE				BODY COLOUR
			15°	24°	38°	60°	
DRL-R 2143	10 W	50X135 MM	15°	24°	38°	60°	WH/BK
DRL-R 2144	15 W	60X150 MM	15°	24°	38°	60°	WH/BK
DRL-R 2145	20 W	80X150 MM	15°	24°	38°	60°	WH/BK
DRL-R 2146	24 W	80X180 MM	15°	24°	38°	60°	WH/BK
DRL-R 2147	30 W	90X180 MM	15°	24°	38°	60°	WH/BK
DRL-R 2148	36 W	100X180 MM	15°	24°	38°	60°	WH/BK
DRL-R 2149	40 W	120X175 MM	15°	24°	38°	60°	WH/BK

DRIVERS

FULHAM
Harness the Horsepower

OSRAM

EAGLE RISE

b,ag, India
Reliable | Intelligent | Drivers

COLOUR TEMPERATURE

27K 3K 4K 5K 6K 3in1 CCT TUNEABLE

LED

BRIDGELUX

CREE



MODEL	WATT	DIMENSION	BEAM ANGLE				BODY COLOUR
			15°	24°	38°	60°	
DRL-R 2150	10 W	50X135 MM	15°	24°	38°	60°	WH/BK
DRL-R 2151	15 W	60X150 MM	15°	24°	38°	60°	WH/BK
DRL-R 2152	20 W	80X150 MM	15°	24°	38°	60°	WH/BK
DRL-R 2153	24 W	80X180 MM	15°	24°	38°	60°	WH/BK
DRL-R 2154	30 W	90X180 MM	15°	24°	38°	60°	WH/BK
DRL-R 2155	36 W	100X180 MM	15°	24°	38°	60°	WH/BK
DRL-R 2156	40 W	120X175 MM	15°	24°	38°	60°	WH/BK

DRIVERS

FULHAM
Harness the Horsepower

OSRAM

EAGLE RISE

bag, India
Reliable | Intelligent | Drivers

COLOUR TEMPERATURE

27K 3K 4K 5K 6K 3in1 CCT TUNEABLE

LED

BRIDGELUX

CREE



MODEL	WATT	DIMENSION	BEAM ANGLE	BODY COLOUR
DRL-R 2157	10 W	50X100 MM	38°	WH/BK
DRL-R 2158	20 W	60X135 MM	38°	WH/BK
DRL-R 2159	30 W	80X150 MM	38°	WH/BK
DRL-R 2160	40 W	90X180 MM	38°	WH/BK

DRIVERS

FULHAM
Harness the Horsepower

OSRAM

EAGLERISE

b,ag, India
Reliable | Intelligent | Drivers

COLOUR TEMPERATURE

27K 3K 4K 5K 6K 3in1 CCT TUNEABLE

LED

BRIDGELUX

CREE



MODEL	WATT	DIME	BEAM ANGLE	BODY COLOUR
DRL-R 2161	12 W	Ø80*100(H)MM	38°	WH/BK
DRL-R 2162	18 W	Ø100*150(H)MM	38°	WH/BK

DRIVERS

FULHAM
Harness the Horsepower

OSRAM

EAGLERISE

b,ag, India
Reliable | Intelligent | Drivers

COLOUR TEMPERATURE

27K 3K 4K 5K 6K 3in1 CCT TUNEABLE

LED

BRIDGELUX

CREE



MODEL	WATT	DIMENSION	BEAM ANGLE				BODY COLOUR
			15°	24°	38°	60°	
DRL-R 2163	10 W	50X135 MM	15°	24°	38°	60°	WH/BK
DRL-R 2164	15 W	60X150 MM	15°	24°	38°	60°	WH/BK
DRL-R 2165	20 W	80X150 MM	15°	24°	38°	60°	WH/BK
DRL-R 2166	24 W	80X180 MM	15°	24°	38°	60°	WH/BK
DRL-R 2167	30 W	90X180 MM	15°	24°	38°	60°	WH/BK
DRL-R 2168	36 W	100X180 MM	15°	24°	38°	60°	WH/BK

DRIVERS

FULHAM
Harness the Horsepower

OSRAM

EAGLERISE

bag, India
Reliable | Intelligent | Drivers

COLOUR TEMPERATURE

27K 3K 4K 5K 6K 3in1 CCT TUNEABLE

LED

BRIDGELUX

CREE



MODEL	WATT	DIMENSION	BEAM ANGLE				BODY COLOUR
			15°	24°	38°	60°	
DRL-R 2169	25 W	80X115 MM	15°	24°	38°	60°	WH/BK
DRL-R 2170	30 W	90X120 MM	15°	24°	38°	60°	WH/BK
DRL-R 2171	36 W	100X120 MM	15°	24°	38°	60°	WH/BK

DRIVERS

FULHAM
Harness the Horsepower

OSRAM

EAGLERISE

bag, India
Reliable | Intelligent | Drivers

COLOUR TEMPERATURE

27K 3K 4K 5K 6K 3in1 CCT TUNEABLE

LED

BRIDGELUX

CREE



MODEL	WATT	OUTER SIZE	CUTOUT SIZE	BEAM ANGLE
DRL-R 2172	7 W	60X85 MM	55 MM	36°
DRL-R 2173	12 W	85X85 MM	75 MM	36°
DRL-R 2174	14 W 7X2	120X69X91 MM	121X60 MM	36°
DRL-R 2175	24 W12X2	180X191X116 MM	164X77 MM	36°

DRIVERS

FULHAM
Harness the Horsepower

OSRAM

EAGLE RISE

b,ag, India
Reliable | Intelligent | Drivers

COLOUR TEMPERATURE

27K 3K 4K 5K 6K 3in1 CCT TUNEABLE

LED

BRIDGELUX

CREE



MODEL	WATT	DIMS	CUTOUT SIZE	BEAM ANGLE
DRL-R 2176	12 W	80 MM	75 MM	36°
DRL-R 2177	18 W	100X95 MM	90 MM	36°
DRL-R 2178	24 W	185X100X95 MM	170X90 MM	36°

DRIVERS

FULHAM
Harness the Horsepower

OSRAM

EAGLERISE

b,ag, India
Reliable | Intelligent | Drivers

COLOUR TEMPERATURE

27K 3K 4K 5K 6K 3in1 CCT TUNEABLE

LED

BRIDGELUX

CREE



MODEL	WATT	OUTER SIZE	CUTOUT SIZE	BEAM ANGLE
DRL-R 2179	3 W	52X52X56 MM	42X42 MM	38°
DRL-R 2180	12 W	128X52X56 MM	120X42 MM	38°
DRL-R 2181	18 W	90X90X56 MM	80X80 MM	38°
DRL-R 2182	24 W	205X52X56 MM	195X52 MM	38°
DRL-R 2183	36 W	128X56MM	120X120MM	38°
DRL-R 2184	40 W	395X52X58MM	395X45MM	38°

DRIVERS

FULHAM
Harness the Horsepower

OSRAM

EAGLERISE

bag, India
Reliable | Intelligent | Drivers

COLOUR TEMPERATURE

27K 3K 4K 5K 6K 3in1 CCT TUNEABLE

LED

BRIDGELUX

CREE



MODEL	WATT	OUTER SIZE	CUTOUT SIZE	BEAM ANGLE
DRL-R 2185	7 W	42x60 MM	35 MM	36°
DRL-R 2186	14 W 7x2	55X62 MM	45 MM	36°

DRIVERS

FULHAM
Harness the Horsepower

OSRAM

EAGLERISE

bag, India
Reliable | Intelligent | Drivers

COLOUR TEMPERATURE

27K 3K 4K 5K 6K 3in1 CCT TUNEABLE

LED

BRIDGELUX

CREE



MODEL	WATT	OUTER SIZE	CUTOUT SIZE	BEAM ANGLE
DRL-R 2187	6 W	97X45X43 MM	91X35 MM	36°
DRL-R 2188	12 W	154X45X43 MM	148X35 MM	36°

DRIVERS



COLOUR TEMPERATURE



LED





MODEL	WATT	OUTER SIZE	CUTOUT SIZE	BEAM ANGLE
DRL-R 2189	3 W	45X45X48 MM	39X39 MM	36°
DRL-R 2190	6 W	75X45X55 MM	65X35 MM	36°
DRL-R 2191	12 W	148X45X45 MM	136X32 MM	36°
DRL-R 2192	24 W	280X43X65 MM	270X32 MM	36°
DRL-R 2193	36 W	412X45X65 MM	404X32 MM	36°

DRIVERS



COLOUR TEMPERATURE



LED





MODEL	WATT	DIME	BEAM ANGLE
DRL-R 2194	12 W	148X45X32	38°
DRL-R 2195	24 W	280X45X32	38°

DRIVERS



COLOUR TEMPERATURE



LED





MODEL	WATT	OUTER SIZE	CUTOUT SIZE	BEAM ANGLE
DRL-R 2196	12 W	134X34X40 MM	126X28 MM	38°

DRIVERS



COLOUR TEMPERATURE



LED





MODEL	WATT	PCB SIZE
DRL-R 2197	10 W	5 MM / 8 MM
DRL-R 2198	16 W	5 MM / 10 MM
DRL-R 2199	22 W	10 MM
DRL-R 2200	20 W	10 MM

COLOUR TEMPERATURE —————

- 27K
3K
4K
5K
6K
3in1
 CCT TUNEABLE



MODEL	WATT	DIMS	HEIGHT	BEAM ANGLE
DRL-R 2201	12 W	120X50 MM	110 MM	120°
DRL-R 2202	18 W	155X55 MM	145 MM	120°
DRL-R 2203	24 W	170X50 MM	160 MM	120°

DRIVERS



COLOUR TEMPERATURE



LED



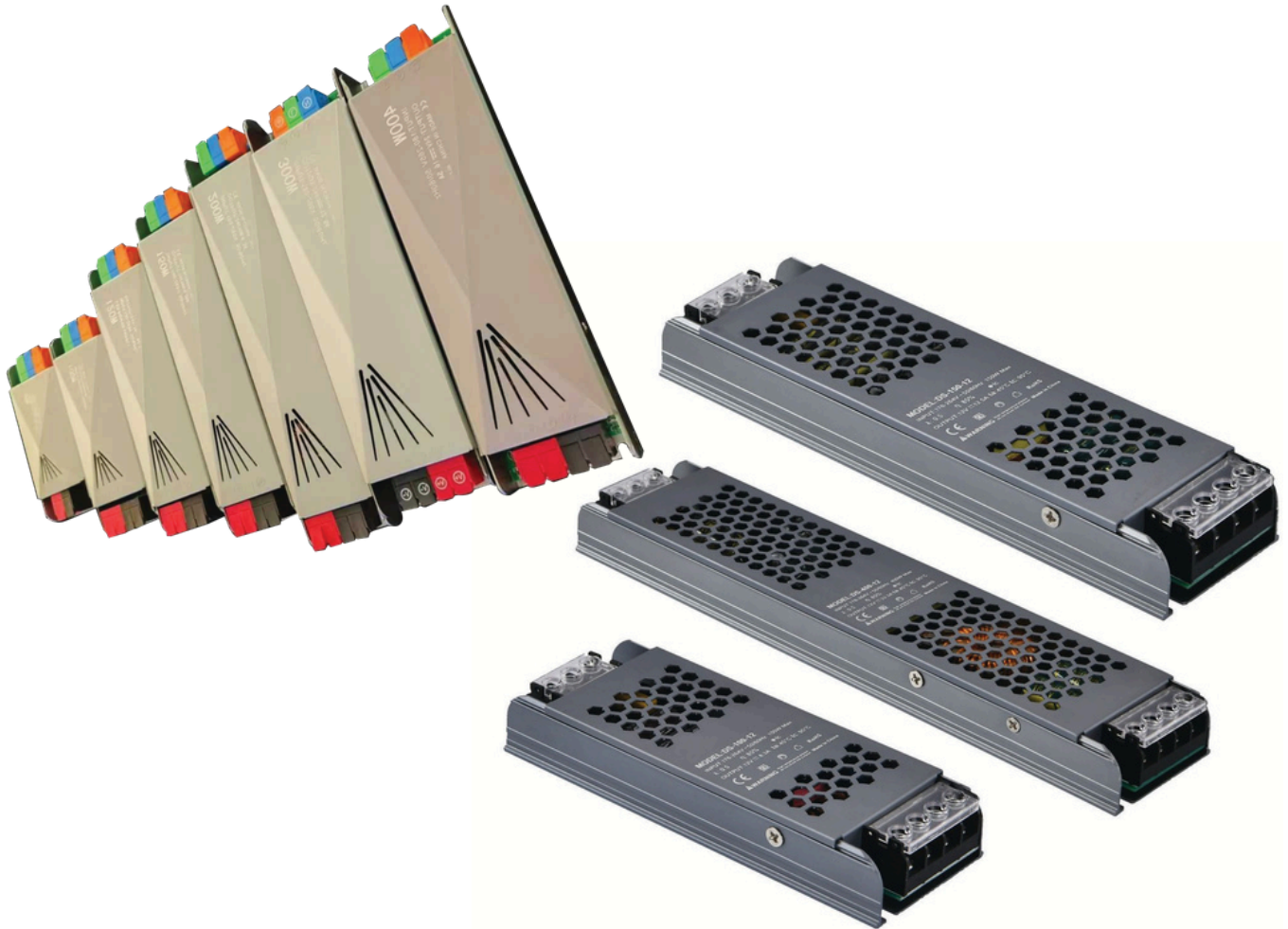

MODEL	WATT	DIMS
DRL-R 2204	36 W	95X35X23 MM
DRL-R 2205	60 W	120X35X23 MM
DRL-R 2206	100 W	124X43X23 MM
DRL-R 2207	120 W	124X43X23 MM
DRL-R 2208	150 W	158X50X23 MM
DRL-R 2209	200 W	165X50X23 MM
DRL-R 2210	300 W	208X50X23 MM
DRL-R 2211	400 W	238X50X23 MM

Knowledge of Lights

Lumen (Unit: lm)

Lumen is the standard unit for measuring luminous flux, indicating the total quantity of visible light emitted by a source. It reflects the overall brightness of the luminaire.

Beam Angle (Unit: degrees)

Beam angle defines the spread of light emitted from a source. It's the angle where luminous intensity drops to 50% of its peak, determining how narrow or wide the light beam will appear.

Colour Temperature (Unit: Kelvin)

Measured in Kelvin (K), color temperature defines the appearance of the light emitted—ranging from warm (yellowish) to cool (bluish) tones. It's based on the temperature of a black-body radiator that emits light of a similar color.

Lux (Unit: lx)

Lux quantifies the amount of light hitting a surface. One lux equals one lumen per square meter, providing a direct measure of illumination intensity in a space.

Driver

A driver is the essential electronic component that regulates and supplies the correct power to LED light sources, ensuring consistent performance and safety.

Light Emitting Diode (LED)

An LED is a semiconductor device that transforms electrical energy into visible light, offering energy efficiency, longevity, and superior performance.

Colour Rendering Index (CRI)

CRI measures a light source's ability to reveal the true colors of objects in comparison to natural light. Rated on a scale of 0 to 100, higher CRI ensures more accurate color representation.

Kelvin

Kelvin is the unit used to describe color temperature, helping to distinguish between warm, neutral, and cool tones in lighting environments.

Tunable & Dimmable LED

LEDs from DORO are fully dimmable and tunable, enhancing ambiance while improving energy efficiency. Dimming methods include

- A. Triac/Phase Cut (Leading or Trailing Edge)
- B. 1-10V DC Analog Dimming
- C. DSI (Digital Signal Interface)
- D. DALI (Digital Addressable Lighting Interface)

IES Files

IES files, developed by the Illuminating Engineering Society (IESNA), provide standardized photometric data. Lighting designers use these files to simulate real-world lighting performance in professional design software.

LED Driver

DORO Lights incorporates top-tier drivers from Fulham/Eaglerise/Osram/Philips – renowned global manufacturers. These constant-current drivers ensure optimal power delivery and come with a 2-year warranty.

COB (Chip-On-Board) LED

COB technology mounts multiple LED chips directly onto a substrate to form a single module. This design reduces thermal resistance and improves light output and heat management.

Design Adaptability

DORO embraces modular design to stay ahead in a fast-evolving LED industry. Future-proofing ensures seamless upgrades to next-generation modules without overhauling fixture designs.

Colour Consistency in LEDs

DORO ensures consistent light quality through LED binning and MacAdam step classification. Each LED is categorized based on color, brightness, and voltage, maintaining uniform appearance across installations.

Heat Management

Proper thermal design is critical to LED performance. DORO fixtures incorporate high-grade heat sinks that dissipate heat efficiently, extending the life and reliability of the LEDs.

Dimming Control Protocols

Flickering often arises from mismatched drivers and control systems. At DORO, we ensure compatibility between our LEDs and drivers to deliver stable, flicker-free lighting performance.

Why Lumens Matter More Than Watts











In LED technology, lumen output is the true measure of performance – not wattage. As efficiency improves, newer LEDs produce significantly more lumens per watt, making wattage a less relevant metric.

Suggestive Lux Level

Area	Lux
Offices – conference rooms	750
Shops	
Super markets	500
Show rooms – Car & General	500
Schools – Classrooms	500
Multi-Purpose Sports Hall	
Tabel Tennis, Gymnasium, Squash	500
Hospitals	
General	300
Examination	1000
Corridors General	150
Reception / Enquiry	300
Homes	
Living Rooms	
- Casual Rooms	150
-Desk and Prolonged Reading	300
Hotels	
Reception/Cashiers/Lobby	300
Coffee Bar/Restaurants	150

IP Protection Codes

The IP prefix followed by two significant digits indicates the fixture's resistance to the penetration of solids and liquids safety rating (IEC 259 issue) 1st digit: against the penetration of solid body and contact with live components. 2nd digit against penetration by liquids.

IP20	Protection against ingress of solids objects of $\varnothing \geq 12\text{mm}$. No protection against water.
IP40	Protection against ingress of solids objects of $\varnothing \geq 1\text{mm}$. No protection against water.
IP43 	Protection against ingress of solids objects of $\varnothing \geq 1\text{mm}$ and against falling rain.
IP44 	Protection against ingress of solids objects of $\varnothing \geq 1\text{mm}$ and against water splashes from all sides.
IP54 	Protection against ingress of dust and water splashes from all sides.
IP55 	Protection against ingress of dust and jets of water from all directions.
IP64 	Protection against ingress of dust and water splashes from all directions.
IP65 	Protection against ingress of dust and jets of water from all directions.
IP67  	Dust-tight and protected against the effects of temporary immersion.
IP68  	Water splashed against the enclosure from any direction shall have no harmful effect.

